

FASTLED 2 540-910W





CONSTRUCTION FEATURES

BODY:	Extruded aluminium body anodized in black, colour RAL 9005																																				
	External screws and particulars in stainless steel																																				
SCREEN:	Flat tempered closing glass thickness 4mm resistant to thermal shock and impact																																				
GASKETS:	Made of silicone																																				
POWER UNITS:	IP67/65 independent driver fixed on the body with special brackets																																				
	Expected life of the driver 100.000h (@Tc 70°C) Supply voltage 115÷277V 50/60 Hz. Power correction factor >0.92 Insulation class I																																				
CONNECTION:	Power supply through terminal block 2P+T of 6 mm ² inserted in Nylon watertight distribution box																																				
	Cable entry with M20 cable gland suitable for cable with diam. 9÷13 mm																																				
LED MODULES:	Multichip 24 LED modules of last generation with secondary optic in PMMA; available photometries: asymmetric 50° and 65°, circular 21°, 45° and 65°																																				
	LED lighting source with high efficiency (149 lm/W @ 700mA 85°) Expected LEDs life: 100.000 h L80B10, 120.000 h L70B20 version at 700 mA 50.000 h L80B10, 70.000 h L70B20 version at 800 mA																																				
OVERVOLTAGE PROTECTION:	Protected against overvoltage in differential mode up to 10kV and in a common mode up to 6kV Available on request with SPD 10kV 10kA																																				
INSTALLATION:	Equipped with goniometer to regulate the inclination by step of 5°																																				
DIMMING:	<p>AND not-dimmable driver</p> <p>AFD programmable power supply driver with the following features: AOC - setting the maximum output current CHRONO TIMER - power reduction in stand alone mode till 5 levels</p> <div style="display: flex; justify-content: space-around;"> <table border="1"> <caption>Chrono timer 1 (save 24%)</caption> <thead> <tr><th>Time</th><th>Power %</th></tr> </thead> <tbody> <tr><td>15:00</td><td>100</td></tr> <tr><td>22:00</td><td>70</td></tr> <tr><td>01:00</td><td>50</td></tr> <tr><td>04:00</td><td>70</td></tr> <tr><td>06:00</td><td>100</td></tr> </tbody> </table> <table border="1"> <caption>Chrono timer 2 (save 28%)</caption> <thead> <tr><th>Time</th><th>Power %</th></tr> </thead> <tbody> <tr><td>15:00</td><td>100</td></tr> <tr><td>21:00</td><td>70</td></tr> <tr><td>00:00</td><td>50</td></tr> <tr><td>04:00</td><td>70</td></tr> <tr><td>06:00</td><td>100</td></tr> </tbody> </table> </div> <p>CLO - constant lumen output Graduate increase of the output power to balance the natural decrease of the LED flux</p>	Time	Power %	15:00	100	22:00	70	01:00	50	04:00	70	06:00	100	Time	Power %	15:00	100	21:00	70	00:00	50	04:00	70	06:00	100												
	Time	Power %																																			
15:00	100																																				
22:00	70																																				
01:00	50																																				
04:00	70																																				
06:00	100																																				
Time	Power %																																				
15:00	100																																				
21:00	70																																				
00:00	50																																				
04:00	70																																				
06:00	100																																				
	<table border="1"> <thead> <tr><th>Working Hours</th><th>Power Level</th></tr> </thead> <tbody> <tr><td>0</td><td>90</td></tr> <tr><td>2500</td><td>91</td></tr> <tr><td>5000</td><td>91</td></tr> <tr><td>7500</td><td>92</td></tr> <tr><td>10000</td><td>92</td></tr> <tr><td>12500</td><td>93</td></tr> <tr><td>15000</td><td>93</td></tr> <tr><td>17500</td><td>94</td></tr> <tr><td>20000</td><td>94</td></tr> <tr><td>22500</td><td>95</td></tr> <tr><td>25000</td><td>95</td></tr> <tr><td>27500</td><td>97</td></tr> <tr><td>30000</td><td>98</td></tr> <tr><td>32500</td><td>98</td></tr> <tr><td>35000</td><td>99</td></tr> <tr><td>37500</td><td>99</td></tr> <tr><td>40000</td><td>100</td></tr> </tbody> </table>	Working Hours	Power Level	0	90	2500	91	5000	91	7500	92	10000	92	12500	93	15000	93	17500	94	20000	94	22500	95	25000	95	27500	97	30000	98	32500	98	35000	99	37500	99	40000	100
Working Hours	Power Level																																				
0	90																																				
2500	91																																				
5000	91																																				
7500	92																																				
10000	92																																				
12500	93																																				
15000	93																																				
17500	94																																				
20000	94																																				
22500	95																																				
25000	95																																				
27500	97																																				
30000	98																																				
32500	98																																				
35000	99																																				
37500	99																																				
40000	100																																				
COMPOSITION OF THE PURCHASE CODE:	AAN dimmable driver I-10V																																				
	ADA dimmable driver DALI																																				
	0138I XX Y Z K AAA (/8) where the digits identify 0138I = product family XX = numbers of LEDs Y = luminaire colour Z = CCT (4 is 4000K) K = photometry (see table page 3) AAA = dimming (see table page 3) /8 = solution at 800mA																																				



TECHNICAL FEATURES

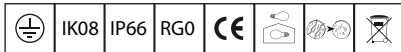

Identification data

Code	Name	Watt	mA max	N.Led	LED Lm	Lm output	Kelvin	CRI	IP	CL	Col	Weight
013816434_	FASTLED 2 PR 64LED 540W 4K	540	700	64	76800	65000	4000 ○	75	66	I	■	30
013816434_/_/8	FASTLED 2 PR 64LED 640W 4K	640	800	64	84800	71700	4000 ○	75	66	I	■	31
013819634_	FASTLED 2 PR 96LED 800W 4K	800	700	96	115200	97500	4000 ○	75	66	I	■	43
013819634_/_/8	FASTLED 2 PR 96LED 910W 4K	910	800	96	127200	107550	4000 ○	75	66	I	■	45

For composition of purchase code see page 2

Photometric data

Last number	Optic
4	ASI $\alpha=65^\circ$
5	AS $\alpha=50^\circ$
7	21°
8	45°
9	65°

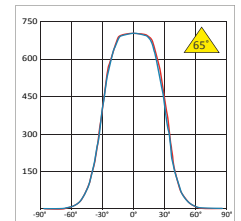
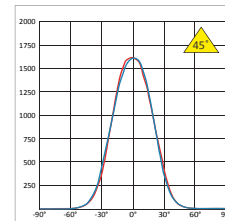
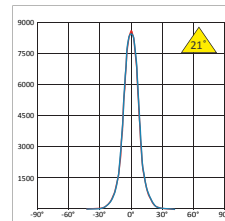
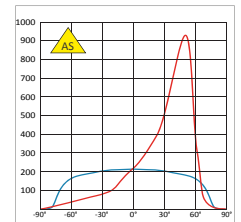
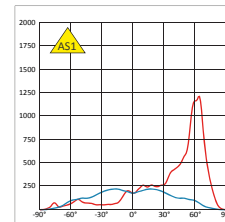

Group of photobiological risk according to EN62471 EXEMPT (RG0)

Dimming

Order code	Dimming profile
AND	not dimmable
AFD	programmable dimming
AAN	dimming 1-10V *
ADA	dimming DALI *

* only for 700mA solution

Dimensions

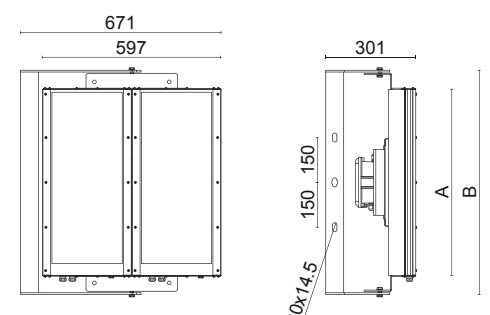

[W]	A	B
540	442	570
640		
800	622	750
910		



Via Papa Giovanni XXIII
21040 Uboldo (VA) Italy
Phone +39 02 96787811
Fax +39 02 96788846
www.faeber.com